

Hi-Q Components

Hi-Q Electronics Ltd, PO Box 302 015, North Harbour, Auckland, New Zealand Ph + 64 9 415 3333 Fax + 64 9 415 8686

Excellent tactile feel when used with overlay membrane.

Specifications KRS Series

Contact Rating : 50 mA 12VDC Travel : 0.25mm

Operating Force : 160g (260g available) Endurance : 10,000 cycles at 10 cpm

KRS 0612 Series

Miniature and versatile thru hole mount.

Drilling Patten



Part Number	Dim. 'A'
41-KRS0612 / 4.3	4.3
41-KRS0612 / 5.0	5.0
41-KRS0612 / 7.3	7.3
41-KRS0612 / 9.5	9.5

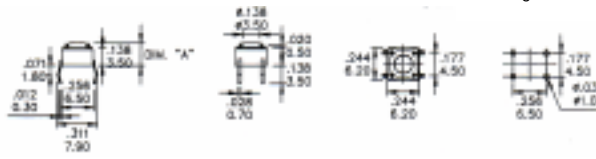

KRS 12 Series

General Purpose Types with range of actuators. Positive Tactile Feel. Through Hole Mount. For SMD Versions add Suffix SMD.



KRS1243



KRS1275



KRS12120

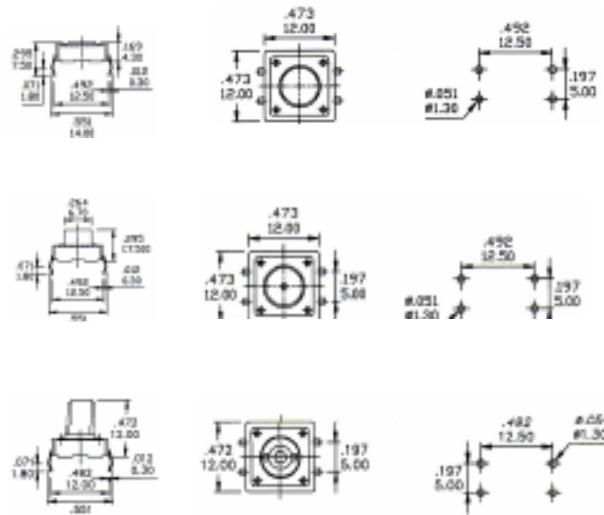

Drilling Patterns

Part Number	Height 'L' above PCB
41-KRS1243	4.3
41-KRS1275	7.5
41-KRS12120	12.0

KRS 1273 switch can be used with spacers for a wide range of overlay heights.

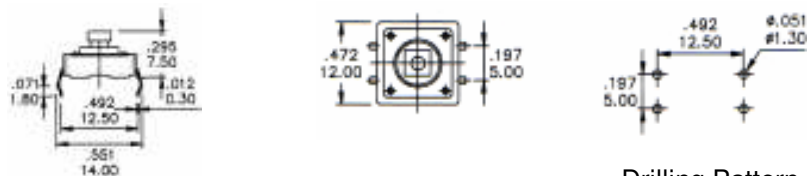

Drilling Pattern

Part No. 41-KRS1273
SMD Version Part No. 41-KRS1273SMD

Select spacer for reqd. dimension 'L'
Spacers must be ordered separately

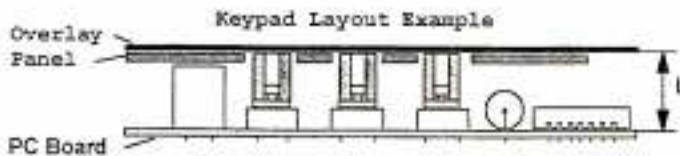

Spacer Part No.	Spacer Nominal Length	'L' PCB to Overlay
Without Spacer	0	7.5
41-KS04.8	4.8	9.1
41-KS06.4	6.4	10.7
41-KS08.0	8.0	12.3
41-KS09.5	9.5	13.8
41-KS11.1	11.1	15.4

Non stock sizes up to 'L' = 42.4mm

Cap for KRS1273

To use as stand alone switch or keypad.



Cap Part Nos. 41-KSC2GREY

41-KSC2BLUE, KSC2GREEN, KSC2RED

41-KSC2YELLOW, KSC2WHITE, KSC2BLACK

Hi-Q Components

Hi-Q Electronics Ltd, PO Box 302 015, North Harbour, Auckland, New Zealand Ph + 64 9 415 3333 Fax + 64 9 415 8686

KRS 0614

Right Angle Momentary Tactile.
Through Hole Mount
Stock Actuator Length 3.2mm
Other lengths up to 15.9mm
Part No. 41-KRS0614

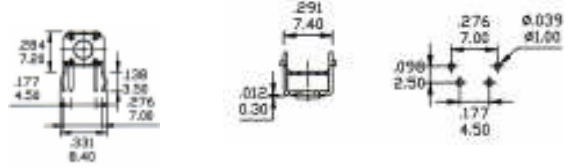
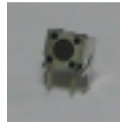

Drilling Pattern

KRS0316

Edge Mount Tactile.
Surface Mount

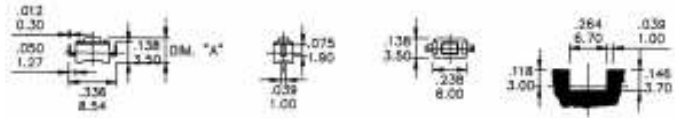

Part No. 41-KRS0316

Land Pattern

LP Series

Illuminated Tactile Switch.
Specifications:
Switch : SPST rated 12VDC 50mA
Operating Temp. : -20°C to +70°C
Contact Resistance : 100 milli ohm
Operating Life : 100,000 cycles min.
LED Rating : 20mA 4v.

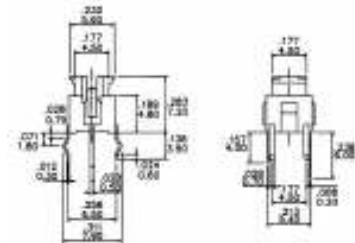

Switch Part Number	LED Colour
41-LP13	No LED
41-LP13R	Red
41-LP13G	Green
41-LP13Y	Yellow

CAPS

Colour : Grey

Part No 41-LP13A

Part No 41-LP13B

KRSM6 Series

Miniature
Positive Tactile Feel
Surface Mount Device



Land Pattern

Part Number	Height mm above PCB
41-KRSM6-1	4.3
41-KRSM6-2	5.0
41-KRSM6-4	7.3
41-KRSM6-5	9.5

KRSM3- Series

Sub Miniature
Surface Mount Device

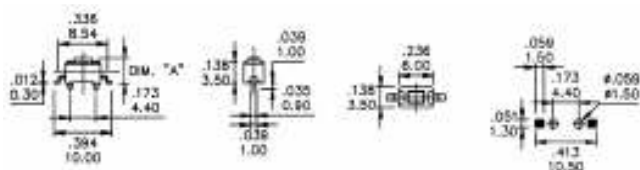

Land pattern

Part Number	Height mm above PCB
41-KRSM3C-1	4.3
41-KRSM3C-2	5.0