

Hi-Q Components

Hi-Q Electronics Ltd, PO Box 302 015, North Harbour, Auckland, New Zealand Ph + 64 9 415 3333 Fax + 64 9 415 8686

A range of top quality terminal blocks at prices which can mean savings for you.

Low Profile Wire Protector Style

Miniature

2 & 3 Pole Modular Interlocking
 Housing: Polyamide 66 Green (UL94V0)
 Wire Guard: Phosphor Bronze Nickel Plated
 Voltage Rating: 300V
 Approvals : UL , VDE, CE

Vertical



32-DED350V-2P



32-DT126VP-3P



32-DED508V-2P

Part No.	Poles	Pitch mm	Max Current	Max mm ²
32-DED350V-2P	2	3.5	10A	1.5
32-DED350V-3P	3	3.5	10A	1.5

Screws M2 Combination
 Torque 2 lb-in

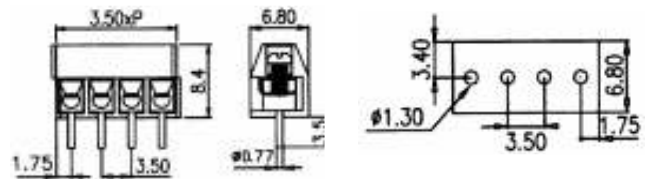

32-DT126VP-2P	2	5.0	8A	1.5
32-DT126VP-3P	3	5.0	8A	1.5

Screws M2.5 Combination
 Torque 4.4 lb-in

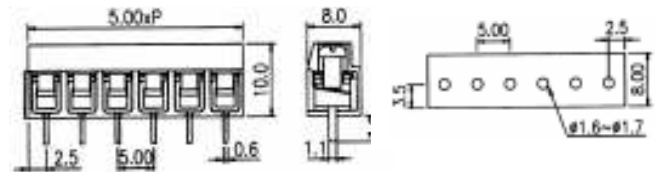

32-DED508V-2P	2	5.08	8A	1.5
32-DED508V-3P	3	5.08	8A	1.5

Screws M2.5 Combination
 Torque 3.5 lb-in

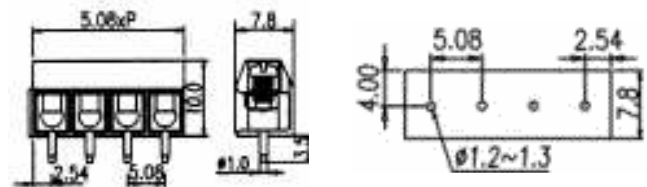

Right Angle



32-DT126RP-3P

Part No.	Poles	Pitch mm	Max Current	Max mm ²
32-DED350R-2P	2	3.5	10A	1.5
32-DED350R-3P	3	3.5	10A	1.5

Screws M2 Combination
 Torque 2 lb-in

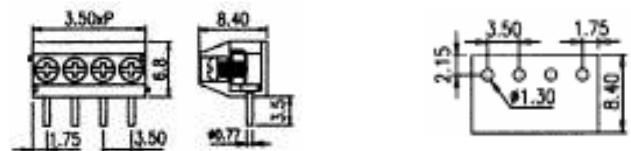

32-DT126RP-2P	2	5.0	8A	1.5
32-DT126RP-3P	3	5.0	8A	1.5

Screws M2.5 Combination
 Torque 4.4 lb-in

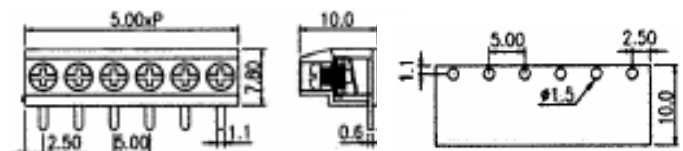

Hi-Q Components

Hi-Q Electronics Ltd, PO Box 302 015, North Harbour, Auckland, New Zealand Ph + 64 9 415 3333 Fax + 64 9 415 8686

A range of top quality terminal blocks at prices which can mean savings for you.

Elevator Clamp Type for secure repeatable connection

2 & 3 Pole Modular Interlocking
Housing: Polyamide 66 Green (UL94V0)
Approvals : UL , VDE, CE

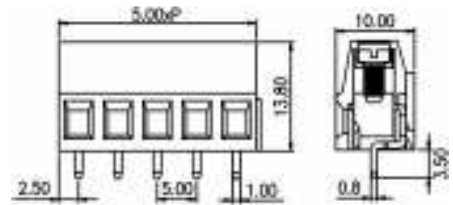

DT128V & DEK508 Series

Vertical

Max Volts: 300V

Part No.	Poles	Pitch mm	Max. Current	Max. mm ²
32-DT128VP-2P	2	5.0	20A	2.5
32-DT128VP-3P	3	5.0	20A	2.5
32-DEK508V-2P	2	5.08	20A	2.5
32-DEK508V-3P	3	5.08	20A	2.5
32-DT128VP-2P3	2	7.5	20A	2.5
32-DT128VP-3P3	3	7.5	20A	2.5

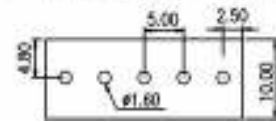

32-DT128VP-xP

DT128R Series

Right Angle

Max Volts: 300V

Part No.	Poles	Pitch mm	Max. Current	Max. mm ²
32-DT128RP-2P	2	5.0	20A	2.5
32-DT128RP-3P	3	5.0	20A	2.5
32-DT128RP-2P3	2	7.5	20A	2.5
32-DT128RP-3P3	3	7.5	20A	2.5

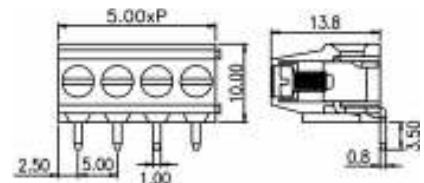

32-DT128RP-xP

DT103 Series

45°Entry

Max Volts: 300V

Part No.	Poles	Pitch mm	Max. Current	Max. mm ²
32-DT103-2P	2	5.0	10A	2.5
32-DT103-3P	3	5.0	10A	2.5

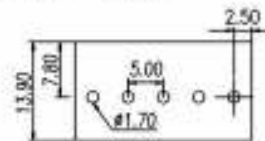
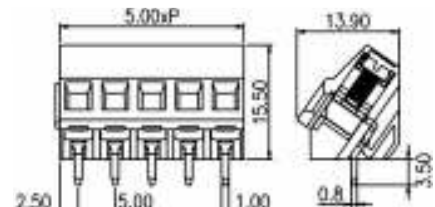

Screws M2.5 Combination

Bi-Level Elevator Clamp Type Dual Vertical

Use with 32-DT128VP series
Approvals : UL , VDE, CE
2Px2 & 3Px2 Modular Interlocking
Pins : 0.8 x 1.0mm
Housing: Polyamide 66 Green (UL94V0)

DEEK500V Series

Max Volts: 300V

Part No.	Poles	Pitch mm	Max. Current	Max. mm ²
32-DEEK500V-2P	4	5.0	20A	2.5
32-DEEK500V-3P	6	5.0	20A	2.5



32-DEEK500V-3P

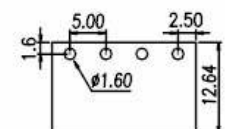
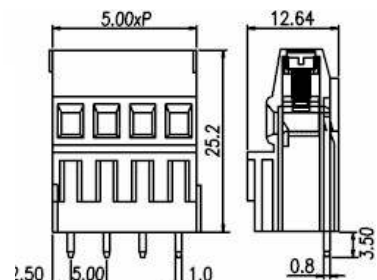

Screws M2.5 Combination

Hi-Q Components

Hi-Q Electronics Ltd, PO Box 302 015, North Harbour, Auckland, New Zealand Ph + 64 9 415 3333 Fax + 64 9 415 8686

A range of top quality terminal blocks at prices which can mean savings for you.

High Voltage Wire Protector Type DT166 Series Vertical

10mm Pitch

Approvals : UL , VDE
12A/4.0mm²/380VAC
Pins : 0.8 x 1.0mm
Housing: Polyamide 6/6 Green (UL94V2)
Screws M3 Combination

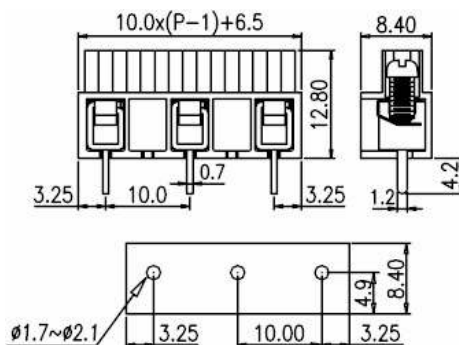

Part No.	Poles	Pitch mm	Max Current	Max mm ²
32-DT166-2P5	2	10.0	12A	4
32-DT166-3P5	3	10.0	12A	4

30A Elevator Clamp Type EK950V Series Vertical

9.52mm Pitch

Approvals : UL, TUV
2 & 3 Pole Modular Interlocking
30A /45.0mm² / 300VAC
Pins : 0.8 x 1.0mm
Housing: Polyamide 6/6 Green (UL94V2)
Screws M3 Combination

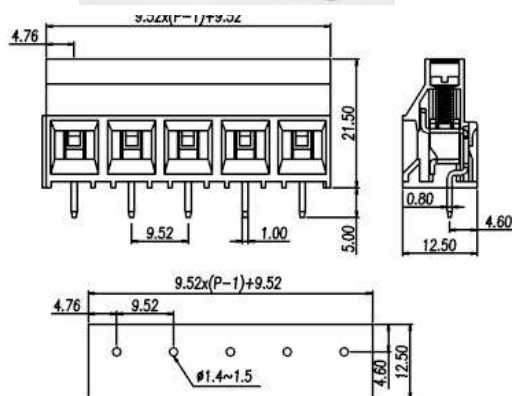

Part No.	Poles	Pitch mm	Max Current	Max mm ²
32-DEK950V-2P	2	9.52	30A	4
32-DEK950V-3P	3	9.52	30A	4