

Hi-Q Components

Hi-Q Electronics Ltd, PO Box 302 015, North Harbour, Auckland, New Zealand Ph + 64 9 415 3333 Fax + 64 9 415 8686

PCB Supports - Screw Mount Type

PFZ Series - Male M4 Thread

- ★ Low cost alternative to PBZ series.
- ★ Fixes into tapped hole or fasten with nut.
- ★ Quick release locking tab.

Part Number	Spacing A 1.5mm PCB	Screw Length B
05-PFZ06	6.3	4.8
05-PFZ16	15.9	4.5

Mounting Holes
PCB 4.0mm
Panel 4.0mm
(M4 Screw Clear)

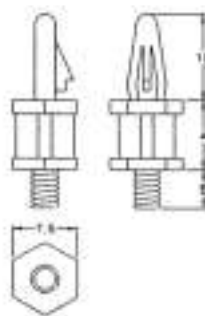

Nylon 6/6

PCB Support - Slide Type

- ★ For mounting without using holes in the PCB.
- ★ Panel clip and spigot for secure and accurate location.

Part Number	Spacing A 1.5mm PCB
05-PUA06	6.4

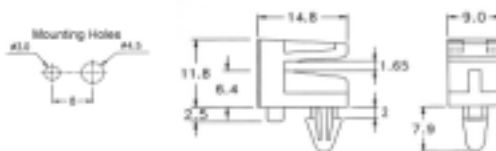

Nylon 6/6

PCB Supports - Rivet Mount Type

- ★ To minimise hole size in panel.
- ★ Neat rivet head for outer panel.
- ★ Mount with 4mm Rivet e.g. 04-PRT460B.

Part Number	Spacing A 1.5mm PCB
05-PTR10	9.5
05-PTR13	12.7
05-PTR16	15.9

Mounting Holes
PCB 4.0mm
Panel 4.0mm

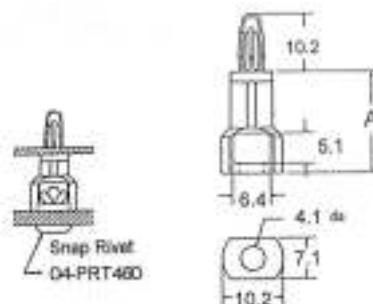

Nylon 6/6

PCB Support - Key-Slot Type

- ★ For use with key hole slot and easy removal of PCB.

Part Number	Spacing 'A' 2.0mm PCB
05-PTM06	6.4
05-PYP06	6.4
05-PYP10	9.5
05-PYP13	12.7
05-PYP16	15.9



PTM
PCB Hole
4.0mm

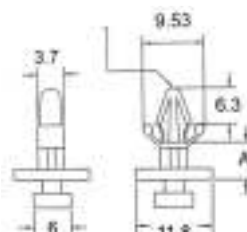

PYP
PCB Hole 4.0mm

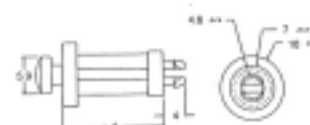

Nylon 6/6

Hi-Q Components

Hi-Q Electronics Ltd, PO Box 302 015, North Harbour, Auckland, New Zealand Ph + 64 9 415 3333 Fax + 64 9 415 8686

PCB Supports - Screw Mount Types

PBU Series Female Self Threading M3 Screw

★ Firm grip locking clip for PCB.

Part Number	Spacing A 1.5mm PCB
05-PBU05	5.0
05-PBU07	7.0
05-PBU10	10.0
05-PBU15	15.0
05-PBU20	20.0
05-PBU25	25.0
05-PBU35	35.0

Mounting Holes

PCB 4.0mm

Panel 3.0mm

(M3 Screw Clearance)

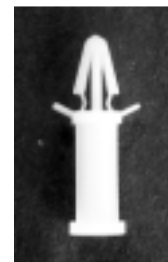
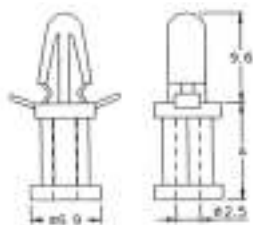

PBX Series Female Self Threading - #6 Self Tap Screw

★ Firm grip locking clip for PCB.

Part Number	Spacing A 1.5mm PCB
05-PBX06	6.5
05-PBX10	10.1
05-PBX13	13.2
05-PBX19	19.6
05-PBX28	29.0
05-PBX35	35.5

Mounting Holes

PCB 4.0mm

Panel 3.6mm

(Clearance for:
6 Self Tapper)

Screw Hole Depth

PBX06 4.5mm

PBX10 5.0mm

Others 8.0mm

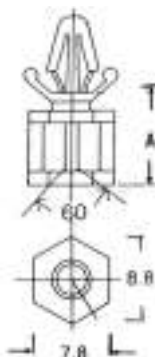

PBY Series - Female Self Threading - #6 Self Tap Screw

★ Quick release locking clip for PCB.

Part Number	Spacing A 1.5mm PCB
05-PBY06	6.3
05-PBY10	9.5
05-PBY13	12.7
05-PBY16	15.9
05-PBY19	19.1
05-PBY25	25.4
05-PBY32	31.8

Mounting Holes

PCB 4.0mm

Panel 3.6mm

(Clearance for:
6 Self Tapper)

Screw Hole Depth

PBY06 4.5mm

Others 8.0mm

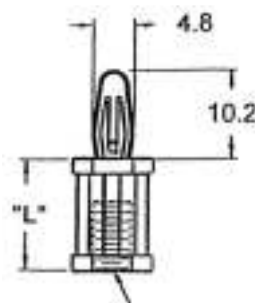

#6 Self



PBZ Series - Female - UNC 8-32 Thread

★ Rigid and insulated support for large spacing.

★ Quick release locking tab

Part Number	Spacing A 1.5mm PCB
05-PBZ06	6.3
05-PBZ10	9.5
05-PBZ13	12.7
05-PBZ16	15.9
05-PBZ19	19.1
05-PBZ25	25.4
05-PBZ35	35.7

Mounting Holes

PCB 4.0mm

Panel 4.3mm

(Clearance for:
UNC 8-32 Screw)

e.g 08-PNS832-08PS

Screw Hole Depth

PBZ06 5.2mm

Others 8.0mm

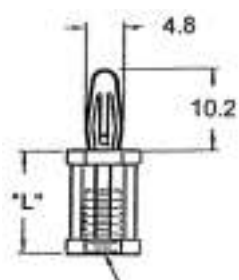

8-32 Thread



Hi-Q Components

Hi-Q Electronics Ltd, PO Box 302 015, North Harbour, Auckland, New Zealand Ph + 64 9 415 3333 Fax + 64 9 415 8686

PCB Supports - Standard Double Barb Types

PAC Series

- ★ Suitable for miniature PCB's.

Part Number	Spacing A 1.5mm PCB
05-PAC06	6.3
05-PAC08	8.0
05-PAC10	10.0
05-PAC12	12.7

Mounting Holes:

Panel & PCB 3.0mm

Panel Thickness

0.8 – 1.8mm

Nylon 6/6

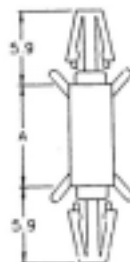

PAF Series

- ★ Suitable for miniature PCB's.

Part Number	Spacing A 1.5mm PCB
05-PAF03	3.2
05-PAF05	5.0
05-PAF06	6.4
05-PAF08	8.0

Mounting Holes:

Panel & PCB 3.0mm

Panel or PCB Thickness

0.8 – 2.0mm

Nylon 6/6

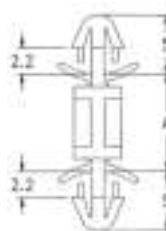

PAD Series

- ★ Suitable for small PCB's.

Part Number	Spacing A 1.5mm PCB
05-PAD06	6.3
05-PAD08	8.0
05-PAD10	9.6
05-PAD12	12.7

Mounting Holes:

Panel & PCB 3.5mm

Panel Thickness

0.8 – 2.0 mm

Nylon 6/6

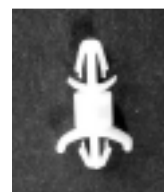
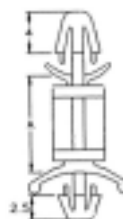

PBA Series

- ★ Quick assembly of standard size PCB's.
- ★ Tension hold option for easy removal of PCB.

Part Number PBAxxL	Part Number PBAxxT	Spacing A 1.5mm PCB
05-PBA05L	05-PBA05T	6.3
05-PBA06L	05-PBA06T	7.7
05-PBA10L	05-PBA10T	11.1
05-PBA13L	05-PBA13T	14.3
05-PBA16L	05-PBA16T	17.3
05-PBA19L	05-PBA19T	20.6
05-PBA25L	05-PBA25T	26.0

Mounting Holes:

PCB 4.0mm

Panel 4.8mm

Panel Thickness

0.8 – 2.0mm

Nylon 6/6

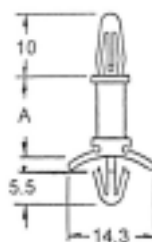
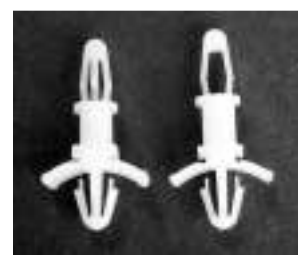

PBA xx L

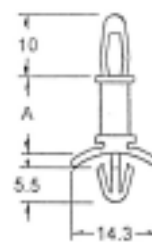

PBA xx T

PBB Series

- ★ Firm spring grip of PCB.

Part Number	Spacing A 1.5mm PCB
05-PBB05	6.3
05-PBB06	7.9
05-PBB10	11.1
05-PBB13	14.2
05-PBB16	17.4
05-PBB19	20.6
05-PBB25	26.0
05-PBB28	28.0

Mounting Holes:

PCB 4.0mm

Panel 4.8mm

Panel Thickness

0.8 – 2.0mm

Nylon 6/6

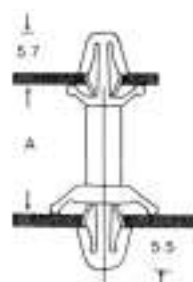

Hi-Q Components

Hi-Q Electronics Ltd, PO Box 302 015, North Harbour, Auckland, New Zealand Ph + 64 9 415 3333 Fax + 64 9 415 8686

PCB Posts - Double End Types

- ★ Ideal for small printed circuit boards or mounting on motherboards.
- ★ Patented design for extra stability. ★ Uses same size holes at each end.

Locking Clip End and Tension Grip End

Part Number	Spacing A 1.5mm PCB
05-PMS03	3.2
05-PMS06	6.3
05-PMS08	8.0
05-PMS10	9.5
05-PMS11	11.1
05-PMS13	12.7
05-PMS16	15.9
05-PMS19	19.1
05-PMS25	25.4
05-PMS45	45.7

PMS
Mounting Holes
4.0mm Dia.
Both Ends

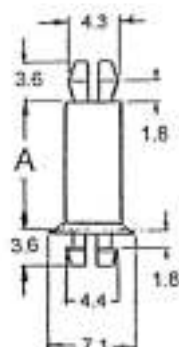

PMS

Nylon 6/6

Locking Clip Both Ends



PMD



PMG

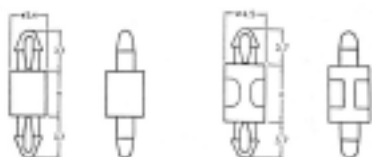

PMM



PMP

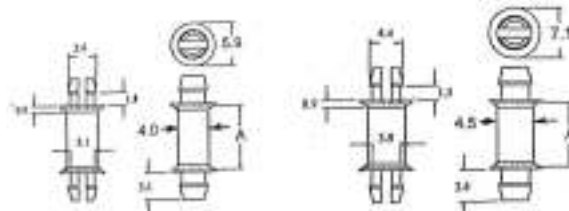

Spacing A 1.5mm PCB	Part Number 2.0mm Dia. Mounting Holes Both Ends	Part Number 2.5mm Dia Mounting Holes Both Ends
3.0	-	05-PMG03
4.0	05-PMD04	05-PMG04
5.0	05-PMD05	05-PMG05
6.3	05-PMD06	05-PMG06
8.0	05-PMD08	05-PMG08
10.5	05-PMD10	05-PMG10

Nylon 6/6

Spacing A 1.5mm PCB	Part Number 3.2mm Dia. Mounting Holes Both Ends	Part Number 4.0mm Dia. Mounting Holes Both Ends
3.2	05-PMM03	05-PMP03
6.3	05-PMM06	05-PMP06
8.0	05-PMM08	05-PMP08
9.5	05-PMM10	05-PMP10
12.7	05-PMM13	05-PMP13
15.9	05-PMM16	05-PMP16
19.1	05-PMM19	05-PMP19
25.4	05-PMM25	05-PMP25

PCB Spacer Support

Part Number	Spacing A
05-PDC030	3.0
05-PDC040	4.0
05-PDC045	4.5
05-PDC050	5.0
05-PDC055	5.5
05-PDC060	6.0

PDC Series
Mounting Hole
3.5mm Dia.

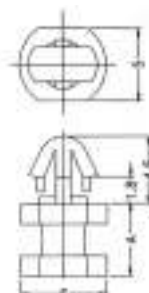

Nylon 6/6

Hi-Q Components

Hi-Q Electronics Ltd, PO Box 302 015, North Harbour, Auckland, New Zealand Ph + 64 9 415 3333 Fax + 64 9 415 8686

PCB Support - Single End Dome Head

- ★ Smooth Dome Head for outer panel applications.

PBR Series

- ★ Strong general purpose support.

Part Number	Spacing A 1.5mm PCB
05-PBR06X	6.3
05-PBR10X	9.5
05-PBR13X	12.7

Mounting Holes
PCB 4.0mm
Panel 6.3mm
Nylon 6/6

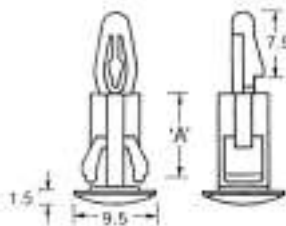

PCR Series

- ★ Firm locking grip for PCB.

Part Number	Spacing A 1.5mm PCB
05-PCR06	6.5
05-PCR10	10.0
05-PCR12	12.0
05-PCR14	14.0

Mounting Holes
PCB 4.0mm
Panel 5.5mm
Nylon 6/6

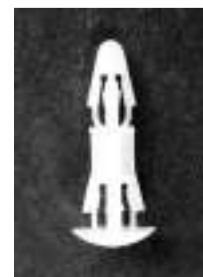
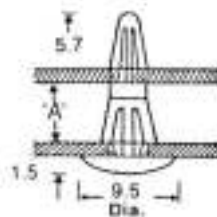

PCY Series - Low Profile

- ★ Minimizes height above PCB.
- ★ Extra stability with thin panels

Part Number	Spacing A 1.5mm PCB
05-PCY06	6.0
05-PCY08	8.0
05-PCY10	10.0
05-PCY12	12.0
05-PCY14	14.0

Mounting Holes
PCB 4.0mm
Panel 5.5mm
Nylon 6/6

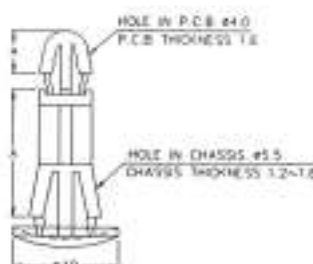

PSR Series

- ★ Ideal for small PCB.
- ★ Easy release barb for PCB.

Part Number	Spacing A 1.5mm PCB
05-PSR06X	6.3
05-PSR09X	9.5
05-PSR12	12.7
05-PSR15	15.9

Mounting Holes
PCB 3.2mm
Panel 4.8mm
X version has hollow dome for extra on thin panels.

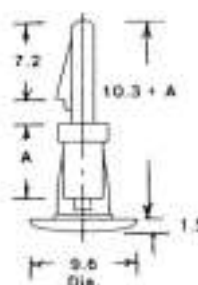

PSY Series - Low Profile

- ★ Ideal for small PCB.
- ★ Extra stability on thin panels

Part Number	Spacing A 1.5mm PCB
05-PSY05	5.0
05-PSY06	6.3
05-PSY08	8.0
05-PSY10	10.0
05-PSY13	12.7

Mounting Holes
PCB 3.2mm
Panel 4.8mm
Nylon 6/6

